

| CATERING EQUIPMENT | COOKING

LUX Pro | 700

DEXION

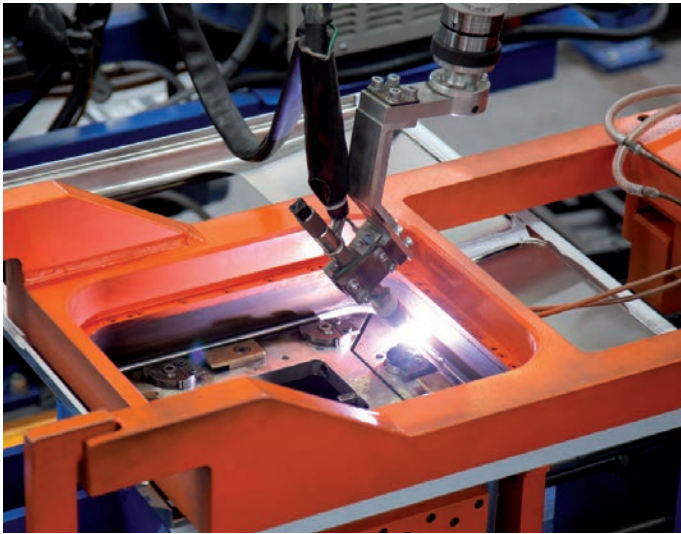

DEXION

50 years of experience at the service of catering professionals

DEXION is a world-class manufacturer of professional catering equipment.

Since 1972, the year the company was founded, **DEXION** has distinguished itself for the quality and reliability of its products and the ability to offer its customers a complete value proposition. Pre-sales service and customer assistance, communication and marketing support, ever-present after-sales assistance and original spare parts are professional values that distinguish **DEXION** both in Italy and internationally.

With a production plant of 17,000 square meters, 16 production lines, **DEXION** establishes itself as a reliable and flexible partner, able to assist its customers at 360°.



1972

DEXION was born as a family company that produces professional kitchens, and began to make itself known for the reliability and excellent quality/price ratio of its products.

1980-1990

The product range is expanding more and more and DEXION acquires numerous market shares, also abroad.

1998

DEXION becomes part of the Eurotec Srl group.

2000

DEXION joins ITW - Illinois Toolworks multinational group, world leader in Food Service Equipment.

LUX Pro | 700



Tradition is renewed

The new **LUX Pro|700** is renewed in design without losing the distinctive features that have made Domina recognizable on the world market. A new design with more ergonomic and elegant lines, with a decisive cut that gives a strong signal of modernity and elegance.





LUX Pro | 700

The real value for your kitchen

Careful to customer needs and market trends, **LUX Pro|700** represents an evolution designed to give a concrete response to customer needs and a unique offer of robust, performing, easy to use and easy to maintain machines.

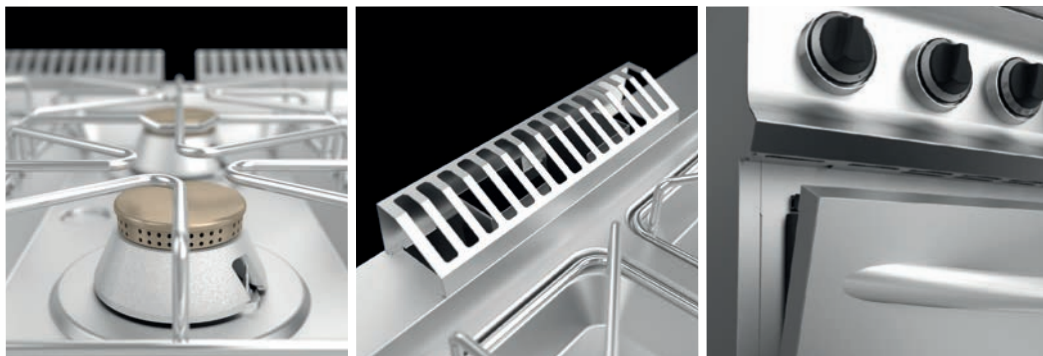

| Solidity

- **New knob**
starting with the finer details, to secure robustness
- **Bottom in stainless steel**
to make the machine more resistant
- **New design structure**
to guarantee maximum solidity
- **IPX5** to guarantee protection to all our components and the durability of our machines



| Performances

- **High power burners**
with 60% certified efficiency
- **New powerful frytop**
to guarantee better uniformity
- **New electric fryers**
to ensure maximum reactivity
- **New lavastone grids with levels**
for superior cooking results



| Cleanability

- **New electric fryers with tilting heating elements** for ease of cleaning of the tank
- **Limited number of screws** for smooth and wipeable surfaces
- **New frytop built in with removable backsplash** to improve the cleaning procedure
- **Removable bottom** to facilitate cleaning the area underneath the machines

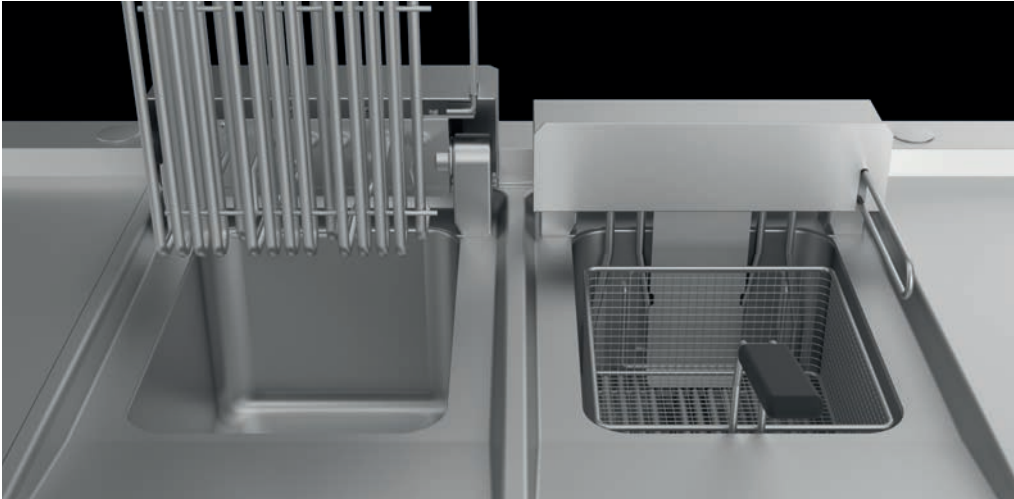

| Ease of maintenance

- **New chimney without screws** easily removable
- **Rear technical compartment** to facilitate connection to utilities
- **New head-to-head connection** for speedy and uncomplicated installations
- **Removable bottom** to allow easy access to the lower part of the equipment



Gas ranges



Flex Burners power (kW)

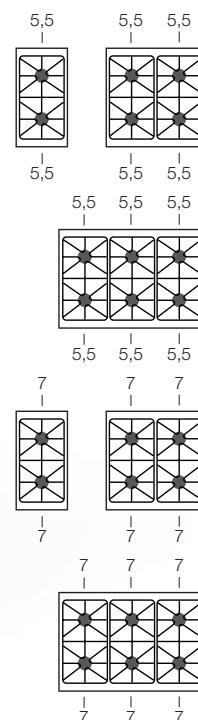

Range Features

Flex Burners with brass burner caps and self-stabilizing flame, to cook safely and for simpler maintenance. Each burner has an adjustable power range, from a minimum of 1.5 kW to a maximum of 5.5 / 7 kW, to get maximum flexibility. The pilot flame is protected inside the main burner. The placement of the burners allows use of pans up to 40 cm in diameter. The single cast iron pan support are dishwasher-size.



Versions with oven

Stainless steel cooking chamber with enameled bottom, stainless steel double-wall door with insulating casing.

Gas oven: 6 kW burner (8 kW for maxi oven) with self-stabilizing flame; thermostatic temperature control with safety valve and thermocouple; piezo-electric burner ignition. 3 GN 2/1 rack support.

Electric oven: 5.3 kW (2,6 kW for ventilated oven) stainless steel armoured heating elements placed on the bottom and on the top of the cooking chamber; thermostatic temperature control with separate bottom/top temperature control for maximum cooking flexibility. 3 GN 2/1 rack support (static oven) and 3 GN 2/1 rack support (ventilated oven).

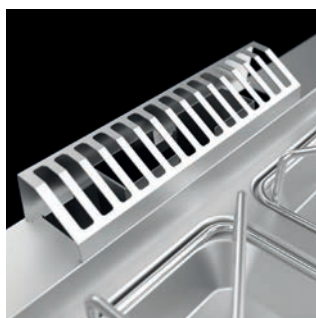

Solidity

- 1.5 mm worktop in AISI 304 18/10 stainless steel
- Pan supports grids in stainless steel
- Stainless steel bottom to guarantee better resistance
- Designed with a water protection IPX5

Performances

- High power Flex Burner: of 5.5 kW or 7 kW
- 60% certified efficiency
- Horizontal flame: uniform heat distribution, also ideal for delicate cooking
- Electric ignition (option) to optimize the use of burners

Cleanability

- Watertight pressed worktop, pressed edges and moulded top to facilitate cleaning operations
- Drain kit (option) to facilitate the cleaning of the pressed worktop
- Limited number of screws to have surfaces without obstacles
- Removable bottom to facilitate cleaning the area underneath the machines

Ease of maintenance

- New chimney without screws quickly removable
- Rear technical compartment to facilitate connection to utilities
- Quick removal of the front panel for a immediate access to components

Electric ranges



Electric plates power (kW)

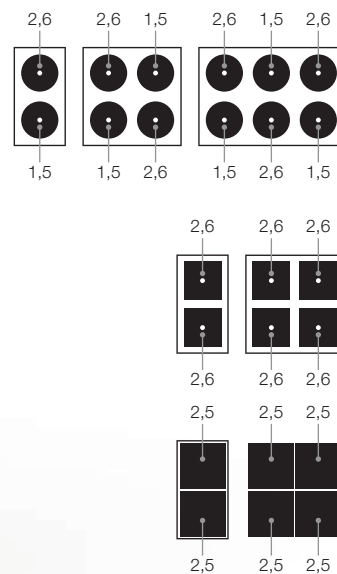

Range features

The cast iron fast-heating hot plates with safety device to prevent overheating are watertight fixed to the worktop. They are available in three versions: rounded with diameter 145/200 mm and power 1.5 kW and 2.6 kW; squared with dimension 220x220 mm and power 2,6 kW; lowered with dimension 300x300 mm and power 2,5 kW.

Indicator lights show when each hotplate is working.

Versions with oven

Stainless steel cooking chamber with enameled bottom, stainless steel double-wall door with insulating casing.

Electric oven: 5.3 kW (2,6 kW for ventilated oven) stainless steel armoured heating elements placed on the bottom and on the top of the cooking chamber; thermostatic temperature control with separate bottom/top temperature control for maximum cooking flexibility. 3 GN 2/1 rack support (static oven) and 3 GN 2/1 rack support (ventilated oven).



Solidity

- 1.5 mm worktop in AISI 304 18/10 stainless steel
- Stainless steel bottom to guarantee better resistance
- Designed with a water protection IPX5

Performances

- Fast-heating hot plates from 50 to 400 °C
- 6 (+1) position switch to regulate the power of each plate

Cleanability

- Watertight pressed worktop, pressed edges and moulded top to facilitate cleaning operations
- Limited number of screws to have surfaces without obstacles
- Removable bottom to facilitate cleaning the area underneath the machines

Ease of maintenance

- New chimney without screws quickly removable
- Rear technical compartment to facilitate connection to utilities
- Quick removal of the front panel for a immediate access to components

Solid top

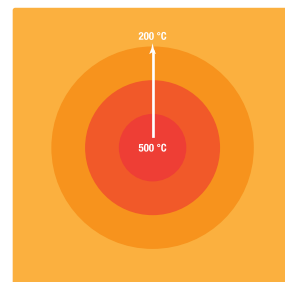

Isothermal zones for differentiated cooking

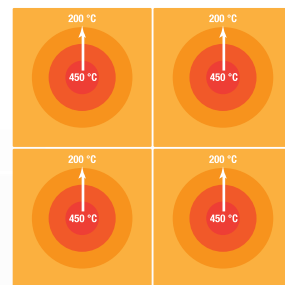

Isothermal zones for differentiated cooking (mod. LXTPE77T, LXTPE77A, LXTPE77FE)

Range features

The cooking plate with a surface area of 40 dm² is in cast iron (10 mm thickness).

For gas versions, the 10 kW stainless steel burner is placed under the removable central ring. Piezo-electric ignition and thermostatic control. For electric versions, the cooking plate is unique but has 4 cooking zone with independent control.

Versions with oven

Stainless steel cooking chamber with enameled bottom, stainless steel double-wall door with insulating casing.

Gas oven: 6 kW burner (8 kW for maxi oven) with self-stabilizing flame; thermostatic temperature control with safety valve and thermocouple; piezo-electric burner ignition. 3 GN 2/1 rack support.

Electric oven: 5.3 kW stainless steel armoured heating elements placed on the bottom and on the top of the cooking chamber; thermostatic temperature control with separate bottom/top temperature control for maximum cooking flexibility. 3 GN 2/1 rack support.

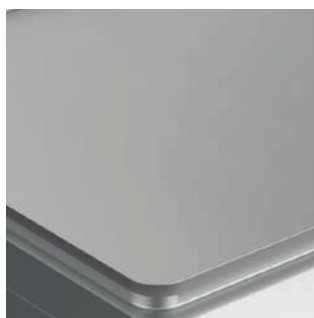
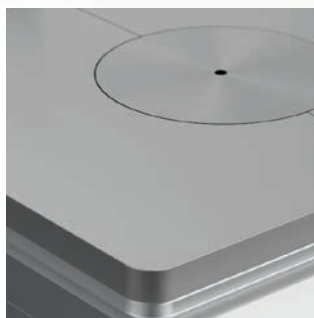

Solidity

- 1.5 mm worktop in AISI 304 18/10 stainless steel
- Cast iron cooking plate, 10 mm thickness for gas versions
- Smooth steel cooking plate, 15 mm thickness for electric versions
- Stainless steel bottom to guarantee better resistance
- Designed with a water protection IPX5

Performances

- Gas versions: possibility to differentiate cooking, temperature range from 500 °C in the centre to 200 °C in the edges
- Electric versions: independent thermostatic temperature control for each cooking zone, from 80 to 450°

Cleanability

- Worktop with pressed edges for liquid collection facilitate cleaning operations
- Limited number of screws to have surfaces without obstacles
- Removable bottom to facilitate cleaning the area underneath the machines

Ease of maintenance

- New chimney without screws quickly removable
- Rear technical compartment to facilitate connection to utilities
- Quick removal of the front panel for a immediate access to components

Glass ceramic



Range features

The sealed 6mm ceramic top offers high cleaning comfort thanks to the flat surface and cleanability of glass ceramic. It is watertight fixed to the worktop, preventing any liquid infiltration.

The heat is produced by means of electric elements underneath and transmitted by diffusion.

Independent temperature regulation for each cooking area, with 3 different power levels. Indicator lights show when each hotplate is active.



Solidity

- 1.5 mm worktop in AISI 304 18/10 stainless steel
- Stainless steel bottom to guarantee better resistance
- Designed with a water protection IPX5

Performances

- Cooking zones power from 1,8 to 2,5 kW
- 3 levels of power setting

Cleanability

- Limited number of screws to have surfaces without obstacles
- Removable bottom to facilitate cleaning the area underneath the machines

Ease of maintenance

- New chimney without screws quickly removable
- Rear technical compartment to facilitate connection to utilities
- Quick removal of the front panel for a immediate access to components

Induction

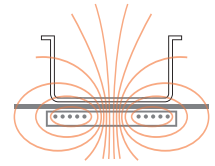

The heat is transmitted only to the bottom of the pan for a more comfortable working environment

Range features

The sealed 6mm ceramic top offers high cleaning comfort thanks to the flat surface and cleanability of glass ceramic. It is watertight fixed to the worktop, preventing any liquid infiltration.

The cooking surface only heats up when in direct contact with induction friendly pans and pots, and the amount of heat is proportional to the surface of contact. The zone of the cooking surface not in contact with the pan remains deactivated and thus cold allowing a more comfortable working environment (lower heat emission) and a energy savings equal to 50% compared to traditional stoves. Each inductor has 6 different power levels and an indicator light shows when the top is in operation.



Solidity

- 1.5 mm worktop in AISI 304 18/10 stainless steel
- Stainless steel bottom to guarantee better resistance
- Designed with a water protection IPX5

Performances

- Cooking zones Ø 220mm and 3.5 kW power (5 kW wok version)
- 6 levels of power setting, for special or delicate cooking

Cleanability

- Smooth surfaces, absence of chimney and limited number of screws to have surfaces without obstacles
- Removable bottom to facilitate cleaning the area underneath the machines

Ease of maintenance

- Rear technical compartment to facilitate connection to utilities
- Quick removal of the front panel for a immediate access to components

Fry top



Range features

The cooking plate with rounded front corners in smooth steel, with polished or solid chrome finish, has a thickness of 15 mm.

Teflon cap (as option) easy to remove to facilitate the cleaning operations and the discharge of grease into a removable stainless steel basin with capacity up to 2 liters. In 70 cm models it's possible to differentiate cooking thanks to independent gas burners/electric heating elements.

The chrome finishing allows to cook different foods in succession without the risk of transferring smells and flavors, thus avoiding having to clean the griddle plate between different cooking. More than facilitating cleaning operations, the chrome finishing is characterized by lower dispersion of heat, making the working environment more comfortable.

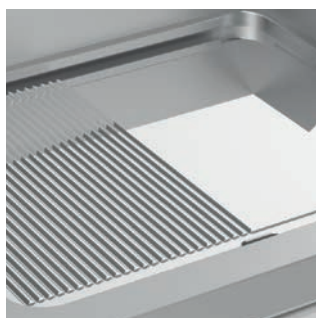
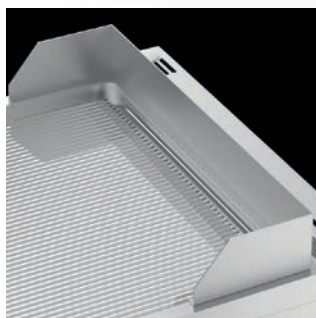

Solidity

- 1.5 mm worktop in AISI 304 18/10 stainless steel
- 15 mm thickness smooth steel cooking plate, polished or solid chrome finish
- Stainless steel bottom to guarantee better resistance
- Designed with a water protection IPX5

Performances

- Temperature uniformity and precise thermostatic control from 145 to 290 °C (gas versions), and from 75 to 290 °C (electric versions), to cook also delicate food
- Possibility to differentiate cooking to optimize the cooking workflow

Cleanability

- New built-in cooking plates, welded on top to guarantee maximum cleanability
- New removable splashguard (optional) to facilitate cleaning operations
- Limited number of screws to have surfaces without obstacles
- Removable bottom to facilitate cleaning the area underneath the machines

Ease of maintenance

- New chimney without screws quickly removable
- Rear technical compartment to facilitate connection to utilities
- Quick removal of the front panel for a immediate access to components

Lavastone grill



Range features

The cooking grid is cast iron made, double face meat/fish. An extractable stainless steel drawer collects grease during cooking. Full moduls (80 cm) have independent heating elements to allow different cooking.



Solidity

- 1.5 mm worktop in AISI 304 18/10 stainless steel
- Robust cast iron grid
- Stainless steel bottom to guarantee better resistance
- Designed with a water protection IPX5

Performances

- Double face cast iron grid meat/fish
- Grids lifting kit available as accessory to allow greater slope and differentiate the temperature cooking

Cleanability

- The three sides splashguard contains greases during cooking
- Briquettes available as an accessory, they are easy to clean and release less fumes into the environment
- Limited number of screws to have surfaces without obstacles
- Removable bottom to facilitate cleaning the area underneath the machines

Ease of maintenance

- New chimney without screws quickly removable
- Rear technical compartment to facilitate connection to utilities
- Quick removal of the front panel for a immediate access to components

Water grill



Range features

The cooking grid is cast iron made, double face meat/fish. An extractable stainless steel drawer with water generates steam during cooking operations.

The water contained in the containers under the electric heating elements/burner evaporates allowing delicate and uniform cooking of food and keeping flavour unchanged. Full moduls (80 cm) have independent heating elements/burner to allow different cooking.

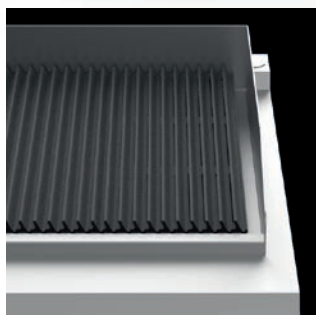

Solidity

- 1.5 mm worktop in AISI 304 18/10 stainless steel
- Robust cast iron grid
- Stainless steel bottom to guarantee better resistance
- Designed with a water protection IPX5

Performances

- Double face cast iron grid meat/fish
- The heat radiated by the heating elements/burner develops steam which rises towards the food on the grid, ensuring delicate and uniform cooking

Cleanability

- Easy cleaning of the grease collection drawer thanks to the presence of water inside
- Smooth surfaces, absence of chimney and limited number of screws to have surfaces without obstacles
- Removable bottom to facilitate cleaning the area underneath the machines

Ease of maintenance

- Rear technical compartment to facilitate connection to utilities
- Quick removal of the front panel for a immediate access to components

Fryers



Range features

The 18/10 AISI 304 stainless steel tanks are continuous-welded with rounded corners for easy cleaning and sanitification.

The used oil outlet system is simple and safe with an oil collection tank with stainless steel filter. All models have safety thermostat and thermostatic temperature control to keep the oil temperature within safety parameters.

Gas versions: models available with direct heating via heating elements in the tank or with indirect heating via a burner outside the V-shaped tank, which guarantees excellent cleaning.

Electric versions: with liftable heating elements to guarantee perfect cleaning of the tank, versions with digital display are also available (LXFRBE74AD - LXFRBE77AD - LXFRBE74AHP) equipped with automatic melting, they allow precise control of the oil temperature, the setting of the cooking time and the setting of automatic programs to set and speed up the most frequent cooking. The HP model also ensures maximum responsiveness essential for obtaining high productivity in small spaces.



Solidity

- 1.5 mm worktop in AISI 304 stainless steel
- Stainless steel bottom to guarantee better resistance
- Designed with a water protection IPX5

Performances

- Thermostatic temperature control from 105 to 185°C (electric vers.) and from 110 to 190°C (gas vers.)
- Large cold zone to keep the quality of the oil unchanged longer
- Models with digital display (electric)
- HP version for high productivity
- Gas versions available with indirect heating (V shape tank) or direct heating (internal tubes)

Cleanability

- Tilting heating elements, to allow a perfect cleaning of the tank
- Moulded and continuous-welded tank to facilitate the cleaning operations
- Gas models with V-shaped tank and external burners allow easy cleaning of the tank
- Limited number of screws to have surfaces without obstacles
- Removable bottom to facilitate cleaning the area underneath the machines

Ease of maintenance

- New chimney without screws quickly removable
- Rear technical compartment to facilitate connection to utilities
- Quick removal of the front panel for a immediate access to components

Chip scuttle



Range features

The GN 1/1 AISI 304 stainless steel tank is moulded and continuous-welded. Equipped with double perforated bottom inclined to remove excess frying oil. Electric heating with armoured stainless steel elements, set on the external bottom of the tanks and infrared heating element on top.



Solidity

- 1.5 mm worktop in AISI 304 stainless steel
- Designed with a water protection IPX5

Performances

- Double heating, on bottom and top for a better uniformity

Cleanability

- Smooth surfaces, absence of chimney and limited number of screws to have surfaces without obstacles
- Removable perforated filter, dishwasher safe

Ease of maintenance

- Rear technical compartment to facilitate connection to utilities
- Quick removal of the front panel for a immediate access to components

Pasta cooker



Range features

The moulded tanks are in AISI 316 anti-corrosion stainless steel, with rounded corners for easy cleaning. The optional pasta baskets are in AISI 304 18/10 stainless steel with thermal handle. Electric valve to load the water.

Gas versions: stainless steel burner with self-stabilizing flame. Thermocouple safety device connected to the pilot flame. Piezo-electric burner ignition.

Electric versions: electric heating elements in armoured stainless steel; power adjustment with four position switch; control of the temperature with operating and safety thermostat.



Solidity

- 1.5 mm worktop in AISI 304 stainless steel
- Moulded and continuous-welded tanks
- Stainless steel bottom to guarantee better resistance
- Designed with a water protection IPX5

Performances

- Gas versions: high power stainless steel burner, outside the tank
- Electric version: heating elements inside the tank to increase the efficiency

Cleanability

- Moulded edge for collection of liquids and to facilitate cleaning
- Limited number of screws to have surfaces without obstacles
- Removable bottom to facilitate cleaning the area underneath the machines

Ease of maintenance

- New chimney without screws quickly removable
- Rear technical compartment to facilitate connection to utilities
- Quick removal of the front panel for a immediate access to components

Multifunction



Range Features

The multifunction allows you to carry out a great variety of cookings, thanks to its multiple use as a braising pan, frytop, pasta cooker, bain-marie. The AISI 304 stainless steel tank, with a 10 mm bottom, ensures uniform cooking and a low heat dispersion. The temperature control is made through an operating and safety thermostat (90-300°C).

Armored electrical heating elements. Solenoid valve for water loading. A standard AISI 304 stainless steel lid for the bowl with thermal handle. The used product can be discharged directly into the compartment via a discharge pipe and by easily removing the Teflon cap (standard). The product is collected in an AISI 304 stainless steel basin with a special lid with hole, present in the compartment, which slides on nickel-plated steel guides (all standard).



Solidity

- 1.5 mm worktop in AISI 18/10 stainless steel
- Molded bowl with 10 mm bottom
- Stainless steel bottom to guarantee better resistance
- Designed with a water protection IPX5

Performances

- Temperature uniformity and thermostatic control from 90°C to 300°C, in order to guarantee different types of cooking
- Possibility of multiple use as a braising pan, frytop, pasta cooker, bain-marie.

Cleanability

- Solenoid valve for water filling to facilitate the tank cleaning operations
- Removable Teflon cap facilitates the discharge of liquids directly into the basin with a special lid with a hole
- Limited number of screws to have surfaces without obstacles
- Removable bottom to facilitate cleaning the area underneath the machines

Ease of maintenance

- Rear technical compartment to facilitate connection to utilities
- Quick removal of the front panel for a immediate access to components

Braising pan



Range features

The tank has AISI 304 18/10 stainless steel walls and bottom, rounded corners and the shaped front part to facilitate unloading and cleaning operations. The stainless steel lid is balanced and has strong stainless steel AISI 304 hinges. Easy manual tilting of the tank through an ergonomic front handle. Water load tap placed on the front of the unit.

Gas versions: stainless steel burner with multiple arms for even more heat diffusion; gas valve with thermocouple, thermostatic temperature control (90-320 °C).

Electric versions: armoured heating elements in stainless steel on the external bottom of the tank; thermostatic control (50-300 °C).

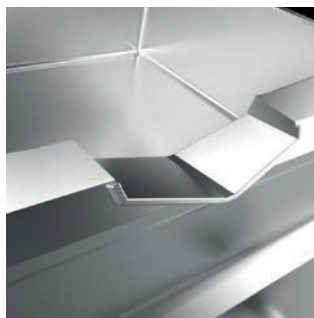

Solidity

- 1.5 mm worktop in AISI 304 stainless steel
- New stainless steel structure guarantees maximum robustness and solidity to the machine
- Stainless steel lid with strong hinges
- Designed with a water protection IPX5

Performances

- Temperature thermostatic control. From 90 to 320 °C (gas version), from 50 to 300 °C (electric version)

Cleanability

- Easy to clean top tanks to the complete tilting of the tank
- Rounded corners facilitate the tank cleaning
- Limited number of screws to have surfaces without obstacles

Ease of maintenance

- New chimney without screws quickly removable
- Rear technical compartment to facilitate connection to utilities
- Quick removal of the front panel for a immediate access to components

Boiling pans



Range features

The tank sides and the interspace are in AISI 304, the bottom is in AISI 316 for greater resistance to corrosion. The AISI 304 lid ensures minimal loss of steam and heat (double insulation lid is available as option to guarantee better thermal insulation). Hot and cold water tap with swivel nozzle is placed on top of the worktop. Indirect heating generated by the low pressure steam of the interspace water evenly heats the surface of the container. Interspace water-level viewer in the front panel.

Gas versions: stainless steel tubular burner with self-stabilizing flame. Pilot flame with thermocouple safety device. Piezo-electric ignition of the pilot. Safety valve with pressure gauge.

Electric versions: power adjustment with 4-position switch, pressure gauge for the automatic control of the interspace steam, safety valve with gauge.



Solidity

- 1.5 mm worktop in AISI 304 stainless steel
- Anti-corrosion AISI 316 stainless steel tank's bottom
- Stainless steel bottom to guarantee better resistance
- Designed with a water protection IPX5

Performances

- Temperature thermostatic control allows delicate cooking

Cleanability

- Moulded watertight worktop, jointsless, with rounded corners, facilitate the top cleaning
- The tank structure allows perfect and fast cleaning
- The drain tap filter easily removable and very easy to clean
- Limited number of screws to have surfaces without obstacles

Ease of maintenance

- No need to empty the tank before maintenance operations thanks to the new front panel which avoids to remove of the drain tap
- Inspectable drain tap to facilitate ordinary cleaning operations
- New chimney without screws quickly removable
- Rear technical compartment to facilitate connection to utilities
- Quick removal of the front panel for a immediate access to components



Range features

The AISI 304 stainless steel tank is moulded and continuous-welded. Electric heating with armoured stainless steel elements, set on the external bottom of the tanks and controlled by a thermostat.



Solidity

- 1.5 mm worktop in AISI 304 stainless steel.
- Stainless steel bottom to guarantee better resistance
- Designed with a water protection IPX5

Performances

- Thermostatic control 0 - 90 °C

Cleanability

- Tank with rounded corners easy to clean
- Smooth surfaces, absence of chimney and limited number of screws to have surfaces without obstacles
- Removable bottom to facilitate cleaning the area underneath the machines

Ease of maintenance

- Rear technical compartment to facilitate connection to utilities
- Quick removal of the front panel for a immediate access to components

LUX Pro | 700

Install **LUX Pro|700** according to your needs:
 totally modular, it allows you to customize and make the best use of any space,
 by creating installations on one line or back to back to double productivity in the kitchen.
 It is possible to create monobloc solutions, on height-adjustable feet or on wheels,
 central or wall-mounted suspended solutions that guarantee maximum cleanability.

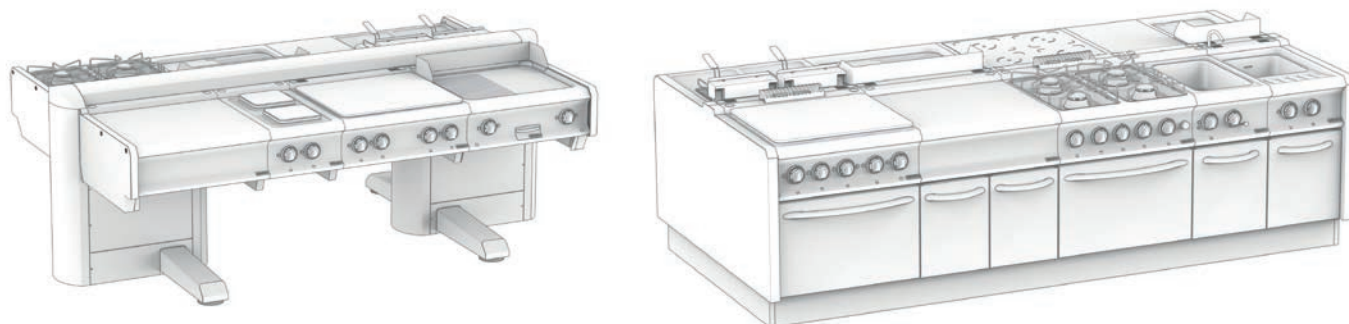

As you like it

You can choose between different colors with professional anti-scratch painting,
 resistant to high temperatures.



RAL 3003



RAL 5005



RAL 9005

A complete series of accessories is available to customize **LUX Pro|700**, including the new end panels that give the structure an elegant design and greater solidity, perimeter handrails, plinths, wheels, water columns, to make the kitchen fully operational according to the your needs.

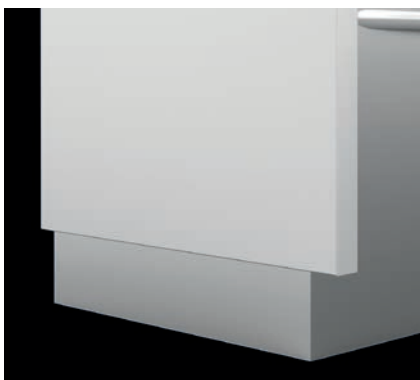

Gas range

IPX5

Model	External dimensions (LxPxH) cm	Oven dimensions (LxPxH) cm	Oven			Total kW	Supply	Gross weight Kg	Volume m ³
			7 kW	Gas kW	El. kW				

on open cabinet

LXFB74AXS	40x73x85	-	-	-	-	11	-	43	0,4
LXFB74AXL	40x73x85	-	2	-	-	14	-	43	0,4
LXFB77AXS	70x73x85	-	-	-	-	22	-	67	0,8
LXFB77AXL	70x73x85	-	4	-	-	28	-	67	0,8
LXFB711AXS	110x73x85	-	-	-	-	33	-	94	1,1
LXFB711AXL	110x73x85	-	6	-	-	42	-	94	1,1

on oven

LXFB77FGXS	70x73x85	56x63x30	-	6	-	28	-	94	0,8
LXFB77FGXL	70x73x85	56x63x30	4	6	-	34	-	94	0,8
LXFB77FEXS	70x73x85	56x63x30	-	-	5,3	22	400V/3N 50/60Hz	95	0,8
LXFB77FEXL	70x73x85	56x63x30	4	-	5,3	28	400V/3N 50/60Hz	95	0,8
LXFB77FEVXS	70x73x85	56x37x32	-	-	2,6	22	230V/1N 50/60Hz	87	0,8
LXFB77FEVXL	70x73x85	56x37x32	4	-	2,6	28	230V/1N 50/60Hz	87	0,8
LXFB711AFGXS	110x73x85	56x63x30	-	6	-	39	-	131	1,1
LXFB711AFGXL	110x73x85	56x63x30	6	6	-	48	-	131	1,1
LXFB711AFEXS	110x73x85	56x63x30	-	-	5,3	33	400V/3N 50/60Hz	134	1,1
LXFB711AFEXL	110x73x85	56x63x30	6	-	5,3	42	400V/3N 50/60Hz	134	1,1
LXFB711FGMXS	110x73x85	77x64x36	-	8	-	41	-	121	1,1
LXFB711FGMXL	110x73x85	77x64x36	6	8	-	50	-	121	1,1
LXFB711MFG4XL	110x73x85	56x63x30	4	6	-	39,5	-	150	1,1

top

LXFB74TXS	40x73x25	-	-	-	-	11	-	32	0,2
LXFB74TXL	40x73x25	-	2	-	-	14	-	32	0,2
LXFB77TXS	70x73x25	-	-	-	-	22	-	54	0,32
LXFB77TXL	70x73x25	-	4	-	-	28	-	54	0,32
LXFB711TXS	110x73x25	-	-	-	-	33	-	70	0,5
LXFB711TXL	110x73x25	-	6	-	-	42	-	70	0,5

Electric range

IPX5

Model	External dimensions (LxPxH) cm	Oven dimensions (LxPxH) cm	Plates			Electric oven kW	Total kW	Supply	Gross weight Kg	Volume m ³
			1,5 kW	2,6 kW	2,5 kW					
on open cabinet										
≡ LXPR74A	40x73x85	-	1	1	-	-	4,1	400V/3N 50/60Hz	35	0,4
≡ LXPQ74A	40x73x85	-	-	2	-	-	5,2	400V/3N 50/60Hz	45	0,4
≡ LXPQR74A	40x73x85	-	-	-	2	-	5	400V/3N 50/60Hz	58	0,4
≡ LXPR77A	70x73x85	-	2	2	-	-	8,2	400V/3N 50/60Hz	60	0,8
≡ LXPQ77A	70x73x85	-	-	4	-	-	10,4	400V/3N 50/60Hz	69	0,8
≡ LXPQR77A	70x73x85	-	-	-	4	-	10	400V/3N 50/60Hz	92	0,8
≡ LXPQ711A	110x73x85	-	-	6	-	-	15,6	400V/3N 50Hz	136	1,1

on oven

≡ LXPR77FE	70x73x85	56x66x31	2	2	-	5,3	13,5	400V/3N 50Hz	90	0,8
≡ LXPQ77FE	70x73x85	56x66x31	-	4	-	5,3	15,7	400V/3N 50/60Hz	99	0,8
≡ LXPQR77FE	70x73x85	56x66x31	-	-	4	5,3	15,3	400V/3N 50/60Hz	125	0,8
≡ LXPQR77FEV	70x73x85	56x37x32	-	-	4	2,6	12,6	230V/1N 50/60Hz	117	0,8
≡ LXPR711FE	110x73x85	56x66x31	3	3	-	5,3	17,6	400V/3N 50/60Hz	136	1,1
≡ LXPQ711FE	110x73x85	56x66x31	-	6	-	5,3	20,9	400V/3N 50Hz	142	1,1

top

≡ LXPR74T	40x73x25	-	1	1	-	-	4,1	400V/3N 50/60Hz	20	0,2
≡ LXPQ74T	40x73x25	-	-	2	-	-	5,2	400V/3N 50/60Hz	27	0,2
≡ LXPR77T	70x73x25	-	2	2	-	-	8,2	400V/3N 50/60Hz	40	0,3
≡ LXPQ77T	70x73x25	-	-	4	-	-	10,4	400V/3N 50/60Hz	49	0,3

Solid top

IPX5

Model	External dimensions (LxPxH) cm	Oven dimensions (LxPxH) cm	Cooking plate		Oven		Total kW	Supply	Gross weight Kg	Volume m ³
			Gas 10 kW	El. 2,25 kW	Gas kW	El. kW				
on open cabinet										
💧 LXTPG77A	70x73x85	-	1	-	-	-	10	-	83	0,8
≡ LXTPE77A	70x73x85	-	-	4	-	-	10	400V/3N 50/60Hz	84	0,8
on oven										
💧 LXTPG77FG	70x73x85	56x66x31	1	-	6	-	16	-	116	0,8
💧 LXTPG711FG2XL	110x73x85	56x63x30	1	-	6	-	30	-	160	1,1
💧 LXTPG7152FG4XL	150x73x85	2 x 56x63x30	1	-	6 + 6	-	50	-	320	1,5
≡ LXTPE77FE	70x73x85	56x66x31	-	4	-	5,3	14,3	400V/3N 50/60Hz	117	0,8
top										
💧 LXTPG77T	70x73x25	-	1	-	-	-	10	-	68	0,3
💧 LXTPG711T2XL	110x73x25	-	1	-	-	-	24	-	100	0,5
💧 LXTPG715T4XL	150x73x25	-	1	-	-	-	38	-	122	0,8
≡ LXTPE77T	40x73x25	-	-	4	-	-	9	400V/3N 50/60Hz	69	0,3

Glass ceramic

IPX5

Model	External dimensions (LxPxH) cm	Oven dimensions (LxPxH) cm	Cooking zones		Electric oven kW	Total kW	Supply	Gross weight Kg	Volume m ³
			1,8 kW	2,5 kW					
on open cabinet									
⚡ LXVC74A	40x73x85	-	1	1	-	4,3	400V/3N 50/60Hz	53	0,4
⚡ LXVC77A	70x73x85	-	2	2	-	8,6	400V/3N 50/60Hz	76	0,8
on oven									
⚡ LXVC77FE	70x73x85	56x66x31	2	2	5,3	13,9	400V/3N 50/60Hz	99	0,8
top									
⚡ LXVC74T	40x73x25	-	1	1	-	4,3	400V/3N 50/60Hz	27	0,2
⚡ LXVC77T	70x73x25	-	2	2	-	8,6	400V/3N 50/60Hz	49	0,3

Induction

IPX5

Model	External dimensions (LxPxH) cm	Cooking zones		Total kW	Supply	Gross weight Kg	Volume m ³
		3,5 kW	5 kW				
on open cabinet							
⚡ LXIN74A	40x73x85	2	-	7	400V/3N 50/60Hz	53	0,4
⚡ LXIN77A	70x73x85	4	-	14	400V/3N 50/60Hz	76	0,8
⚡ LXINW74A	40x73x85	-	1	5	400V/3N 50/60Hz	50	0,4
top							
⚡ LXIN74T	40x73x25	2	-	7	400V/3N 50/60Hz	38	0,2
⚡ LXIN77T	70x73x25	4	-	14	400V/3N 50/60Hz	61	0,3
⚡ LXINW74T	40x73x25	-	1	5	400V/3N 50/60Hz	38	0,2

Fry top

IPX5

Model	Cooking plate			Ext. dimensions (LxPxH) cm	Hotplate (LxPxH) cm	Burners 7 kW	El. elements 5 kW	Total kW	Supply	Gross w. Kg	Volume m ³	
	Smooth	Lined	Chromed									
on open cabinet												
LXFTBG74AL	●			40x73x85	33x54	1	-	7	-	63	0,5	
LXFTBG74ALC	●		●	40x73x85	33x54	1	-	7	-	63	0,5	
LXFTBG74AR		●		40x73x85	33x54	1	-	7	-	63	0,5	
LXFTBG74ARC		●	●	40x73x85	33x54	1	-	7	-	63	0,5	
LXFTBG77AL	●			70x73x85	63x54	2	-	14	-	97	0,8	
LXFTBG77ALC	●		●	70x73x85	63x54	2	-	14	-	97	0,8	
LXFTBG77AR		●		70x73x85	63x54	2	-	14	-	97	0,8	
LXFTBG77ARC		●	●	70x73x85	63x54	2	-	14	-	97	0,8	
LXFTBG77ALR	●	●		70x73x85	63x54	2	-	14	-	97	0,8	
LXFTBG77ALRC	●	●	●	70x73x85	63x54	2	-	14	-	97	0,8	

top												
LXFTBG74TL	●			40x73x25	33x54	1	-	7	-	43	0,2	
LXFTBG74TLC	●		●	40x73x25	33x54	1	-	7	-	43	0,2	
LXFTBG74TR		●		40x73x25	33x54	1	-	7	-	43	0,2	
LXFTBG74TRC		●	●	40x73x25	33x54	1	-	7	-	43	0,2	
LXFTBG77TL	●			70x73x25	63x54	2	-	14	-	75	0,3	
LXFTBG77TLC	●		●	70x73x25	63x54	2	-	14	-	75	0,3	
LXFTBG77TR		●		70x73x25	63x54	2	-	14	-	75	0,3	
LXFTBG77TRC		●	●	70x73x25	63x54	2	-	14	-	75	0,3	
LXFTBG77TLR	●	●		70x73x25	63x54	2	-	14	-	75	0,3	
LXFTBG77TLRC	●	●	●	70x73x25	63x54	2	-	14	-	75	0,3	

on open cabinet												
LXFTBE74AL	●			40x73x85	33x54	-	1	5	400V/3N 50/60Hz	63	0,5	
LXFTBE74ALC	●		●	40x73x85	33x54	-	1	5	400V/3N 50/60Hz	63	0,5	
LXFTBE74AR		●		40x73x85	33x54	-	1	5	400V/3N 50/60Hz	63	0,5	
LXFTBE74ARC		●	●	40x73x85	33x54	-	1	5	400V/3N 50/60Hz	63	0,5	
LXFTBE77AL	●			70x73x85	63x54	-	2	10	400V/3N 50/60Hz	97	0,8	
LXFTBE77ALC	●		●	70x73x85	63x54	-	2	10	400V/3N 50/60Hz	97	0,8	
LXFTBE77AR		●		70x73x85	63x54	-	2	10	400V/3N 50/60Hz	97	0,8	
LXFTBE77ARC		●	●	70x73x85	63x54	-	2	10	400V/3N 50/60Hz	97	0,8	
LXFTBE77ALR	●	●		70x73x85	63x54	-	2	10	400V/3N 50/60Hz	97	0,8	
LXFTBE77ALRC	●	●	●	70x73x85	63x54	-	2	10	400V/3N 50/60Hz	97	0,8	



top												
LXFTBE74TL	●			40x73x25	33x54	-	1	5	400V/3N 50/60Hz	43	0,2	
LXFTBE74TLC	●		●	40x73x25	33x54	-	1	5	400V/3N 50/60Hz	43	0,2	
LXFTBE74TR		●		40x73x25	33x54	-	1	5	400V/3N 50/60Hz	43	0,2	
LXFTBE74TRC		●	●	40x73x25	33x54	-	1	5	400V/3N 50/60Hz	43	0,2	
LXFTBE77TL	●			70x73x25	63x54	-	2	10	400V/3N 50/60Hz	75	0,3	
LXFTBE77TLC	●		●	70x73x25	63x54	-	2	10	400V/3N 50/60Hz	75	0,3	
LXFTBE77TR		●		70x73x25	63x54	-	2	10	400V/3N 50/60Hz	75	0,3	
LXFTBE77TRC		●	●	70x73x25	63x54	-	2	10	400V/3N 50/60Hz	75	0,3	
LXFTBE77TLR	●	●		70x73x25	63x54	-	2	10	400V/3N 50/60Hz	75	0,3	
LXFTBE77TLRC	●	●	●	70x73x25	63x54	-	2	10	400V/3N 50/60Hz	75	0,3	

Lavastone grill



IPX5

Model	External dimensions (LxPxH) cm	Grid dimensions cm	Burners 7,5 kW	Total kW	Gross weight Kg	Volume m ³
-------	-----------------------------------	-----------------------	-------------------	----------	--------------------	--------------------------

on open cabinet

 LXPLG74A	40x73x85	35,2x47,5	1	7,5	55	0,5
 LXPLG78A	70x73x85	35,2x47,5 (x2)	2	15	98	0,8

top



 LXPLG74T	40x73x25	35,2x47,5	1	7,5	36	0,2
 LXPLG78T	70x73x25	35,2x47,5 (x2)	2	15	74	0,3

Water grill

IPX5

Model	External dimensions (LxPxH) cm	Grid dimensions cm	Electric elements 6 kW	Burners 8,5 kW	Total kW	Supply	Gross weight Kg	Volume m ³
-------	-----------------------------------	-----------------------	---------------------------	-------------------	----------	--------	--------------------	--------------------------

on open cabinet











 LXWGE74	40x73x85	35,2x47,5	1	-	6	400V/3N 50/60Hz	50	0,5
 LXWGE78	80x73x85	35,2x47,5 (x2)	2	-	12	400V/3N 50/60Hz	82	0,8
 LXWGG74	40x73x85	35,2x47,5	-	1	8,5	-	50	0,5
 LXWGG78	80x73x85	35,2x47,5 (x2)	-	2	17	-	82	0,8

Fryers



IPX5

Model	External dimensions (LxPxH) cm	Tank dimensions (LxPxH) cm	Tank capacity Lt	Burners kW	El. elements kW	Total kW	Supply	Gross w. Kg	Volume m ³
-------	-----------------------------------	-------------------------------	---------------------	---------------	--------------------	----------	--------	----------------	--------------------------

on open cabinet

 LXFRG74A2V	40x73x118	14x34x30	7+7	6,25+6,25	-	12,5	-	62	0,6
 LXFRG74A	40x73x118	28x34x30	14	12,5	-	12,5	-	57	0,6
 LXFRVG74A	40x73x118	43x31x40	14	15	-	15	230V/1N 50/60Hz	59	0,6
 LXFRG77A	70x73x118	28x34x30	14+14	12,5+12,5	-	25	-	97	1
 LXFRE74A2V	40x73x85	14x34x21	7+7	-	5,25+5,25	10,5	400V/3N 50/60Hz	58	0,5
 LXFRBE74A	40x73x85	24x34x21,5	12	-	9	9	400V/3N 50/60Hz	53	0,5
 LXFRBE77A	70x73x85	24x34x21,5	12+12	-	9+9	18	400V/3N 50/60Hz	72	0,8
 LXFRBE74AD	40x73x85	24x34x21,5	12	-	9	9	400V/3N 50/60Hz	53	0,5
 LXFRBE77AD	70x73x85	24x34x21,5	12+12	-	9+9	18	400V/3N 50/60Hz	72	0,8
 LXFRBE74AHP	40x73x85	31x42x29	15	-	15	15	400V/3N 50/60Hz	55	0,5

top

 LXFRE74T2V	40x73x25	14x34x21	7+7	-	5,25+5,25	10,5	400V/3N 50/60Hz	35	0,2
 LXFRBE74T	40x73x25	24x34x21,5	12	-	9	9	400V/3N 50/60Hz	30	0,2
 LXFRBE77T	70x73x25	24x34x21,5	12+12	-	9+9	18	400V/3N 50/60Hz	53	0,3

Chip scuttle

IPX5

Model	External dimensions (LxPxH) cm	Tank dimensions (LxPxH) cm	Total kW	Supply	Gross weight Kg	Volume m ³
-------	-----------------------------------	-------------------------------	----------	--------	--------------------	--------------------------

top

 LXSP74T	40x73x50	31x51x16	1,35	230V/1N 50/60Hz	23,5	0,2
---	----------	----------	------	-----------------	------	-----

Pasta cooker

IPX5

Model	External dimensions (LxPxH) cm	Tank dimensions (LxPxH) cm	Tank capacity Lt	Burners kW	El. elements kW	Total kW	Supply	Gross w. Kg	Volume m ³
on open cabinet									
🔹 LXCPG74A	40x73x85	31x34x30	26	8,5	-	8,5	230V/1N 50/60Hz	50	0,5
🔹 LXCPG77A	70x73x85	51x31x30	40	13,3	-	13,3	230V/1N 50/60Hz	68	0,8
🌀 LXCPG74A	40x73x85	31x34x30	26	-	5,5	5,5	400V/3N 50/60Hz	44	0,5
🌀 LXCPG77A	70x73x85	51x31x30	40	-	9	9	400V/3N 50/60Hz	58	0,8
top									
🔹 LXCPG77T*	70x73x58	51x31x30	40	13,3	-	13,3	230V/1N 50/60Hz	60	0,8
🌀 LXCPG77T*	70x73x58	51x31x30	40	-	9	9	400V/3N 50/60Hz	50	0,8

* Available from end of the year

Multifunction

IPX5

Model	External dimensions (LxPxH) cm	Tank dimensions (LxPxH) cm	Tank capacity Lt	El. elements kW	Total kW	Supply	Gross w. Kg	Volume m ³
free standing on open stand								
🌀 LXMFE74A	40x73x85	31x45,5x16	15	4,7	4,7	400V/3N 50/60Hz	44	0,5

Braising pan

IPX5

Model	Ext. dimensions (LxPxH) cm	Tank dim. (LxPxH) cm	Cooking surf. dm ²	Tank capacity Lt	Burners kW	El. elements kW	Total kW	Supply	Gross w. Kg	Volume m ³
Free standing tilting / manual turnover										
🔹 LXBRG78A	80x73x85	71x48x15	34	50	13,3	-	13,3	-	113	0,85
🌀 LXBRG78A	80x73x85	71x48x15	34	50	-	9	9	400V/3N 50/60Hz	118	0,85

Boiling pans

IPX5

Model	External dimensions (LxPxH) cm	Pan dimensions (ØxH) cm	Pan capacity Lt	Burners kW	El. elements kW	Total kW	Supply	Gross w. Kg	Volume m ³
Free standing									
🔹 LXPEG7750I	70x73x85	ø40x42	50	12,5	-	12,5	-	91	0,8
🌀 LXPEG7750I	70x73x85	ø40x42	50	-	9	9	400V/3N 50/60Hz	93	0,8

Bain Marie

IPX5

Model	External dimensions (LxPxH) cm	Tank dimensions (LxPxH) cm	Tank capacity	El. elements kW	Total kW	Supply	Gross w. Kg	Volume m ³
on open stand								
🌀 LXBME74A	40x73x85	31x51x16	GN 1/1	1,5	1,5	230V/1N 50/60Hz	34	0,5
🌀 LXBME78A	80x73x85	63x51x16	GN 2/1	3	3	230V/1N 50/60Hz	50	0,8
top								
🌀 LXBME74T	40x73x25	31x51x16	GN 1/1	1,5	1,5	230V/1N 50/60Hz	20	0,2
🌀 LXBME78T	80x73x25	63x51x16	GN 2/1	3	3	230V/1N 50/60Hz	30	0,3



Eurotec s.r.l. - Div. DEXION
Strada Brescello - Cadelbosco, 42041 Brescello (RE) - Italy
Tel. +39 0522 686711 - Fax +39 0522 684517
dexion@itweurotec.it - www.dexion.it

 **Food Equipment Group**